

LOCATION: Main St -- W 15th St
CITY/STATE: Vancouver, WA

QC JOB #: 13418617
DATE: Thu, Jun 11 2015

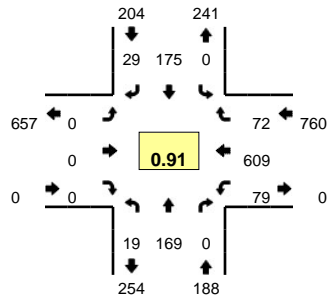

Peak-Hour: 4:00 PM -- 5:00 PM
Peak 15-Min: 4:10 PM -- 4:25 PM

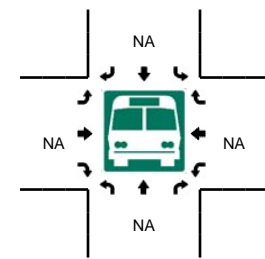
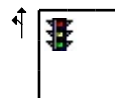
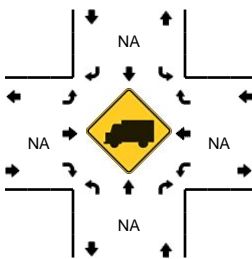
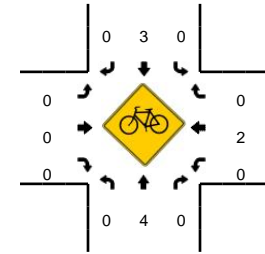
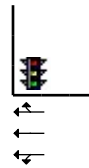
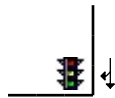
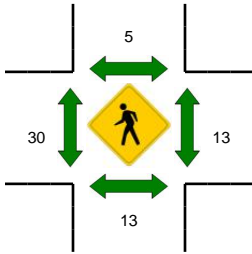
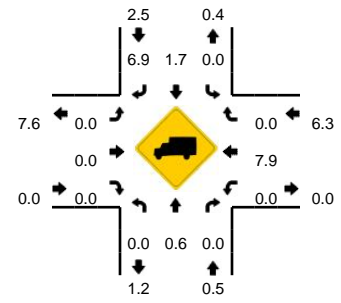

5-Min Count Period Beginning At	Main St (Northbound)				Main St (Southbound)				W 15th St (Eastbound)				W 15th St (Westbound)				Total	Hourly Totals
	Left	Thru	Right	U	Left	Thru	Right	U	Left	Thru	Right	U	Left	Thru	Right	U		
4:00 PM	1	15	0	0	0	14	2	0	0	0	0	0	5	55	8	0	100	
4:05 PM	1	22	0	0	0	13	0	0	0	0	0	0	5	51	5	0	97	
4:10 PM	2	20	0	0	0	16	5	0	0	0	0	0	6	52	5	0	106	
4:15 PM	4	6	0	0	0	16	2	0	0	0	0	0	8	60	5	0	101	
4:20 PM	0	14	0	0	0	19	3	0	0	0	0	0	9	56	9	0	110	
4:25 PM	0	15	0	0	0	17	2	0	0	0	0	0	6	44	2	0	86	
4:30 PM	2	11	0	0	0	15	2	0	0	0	0	0	7	58	4	0	99	
4:35 PM	2	21	0	0	0	14	4	0	0	0	0	0	7	50	7	0	105	
4:40 PM	2	11	0	0	0	13	1	0	0	0	0	0	4	46	4	0	81	
4:45 PM	1	10	0	0	0	6	3	0	0	0	0	0	6	48	11	0	85	
4:50 PM	2	11	0	0	0	14	3	0	0	0	0	0	6	52	6	0	94	
4:55 PM	2	13	0	0	0	18	2	0	0	0	0	0	10	37	6	0	88	1152
5:00 PM	1	17	0	0	0	14	3	0	0	0	0	0	7	43	9	0	94	1146
5:05 PM	5	11	0	0	0	20	2	0	0	0	0	0	4	30	6	0	78	1127
5:10 PM	3	22	0	0	0	24	1	0	0	0	0	0	3	53	3	0	109	1130
5:15 PM	2	20	0	0	0	4	1	0	0	0	0	0	8	34	8	0	77	1106
5:20 PM	3	15	0	0	0	17	1	0	0	0	0	0	7	51	11	0	105	1101
5:25 PM	2	15	0	0	0	13	3	0	0	0	0	0	3	36	4	0	76	1091
5:30 PM	5	13	0	0	0	7	4	0	0	0	0	0	5	49	5	0	88	1080
5:35 PM	0	12	0	0	0	15	0	0	0	0	0	0	6	41	5	0	79	1054
5:40 PM	1	7	0	0	0	17	3	0	0	0	0	0	8	53	4	0	93	1066
5:45 PM	3	13	0	0	0	13	1	0	0	0	0	0	2	30	5	0	67	1048
5:50 PM	3	9	0	0	0	11	2	0	0	0	0	0	9	51	3	0	88	1042
5:55 PM	4	10	0	0	0	19	0	0	0	0	0	0	9	48	7	0	97	1051
Peak 15-Min Flowrates	Northbound				Southbound				Eastbound				Westbound				Total	
	Left	Thru	Right	U	Left	Thru	Right	U	Left	Thru	Right	U	Left	Thru	Right	U		
All Vehicles	24	160	0	0	0	204	40	0	0	0	0	0	92	672	76	0	1268	
Heavy Trucks	0	0	0	0	0	4	4	0	0	0	0	0	0	68	0	0	76	
Pedestrians		4				4				28				8			44	
Bicycles	0	0	0	0	0	2	0	0	0	0	0	0	0	1	0	0	3	
Railroad																		
Stopped Buses																		

Comments: N/A