

LOCATION: W 26th Ave -- W Fourth Plain Blvd
CITY/STATE: Vancouver, WA

QC JOB #: 14671712
DATE: Tue, Apr 10 2018

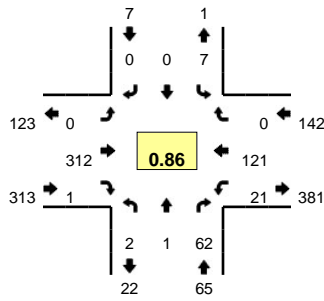

Peak-Hour: 4:25 PM -- 5:25 PM
Peak 15-Min: 5:05 PM -- 5:20 PM

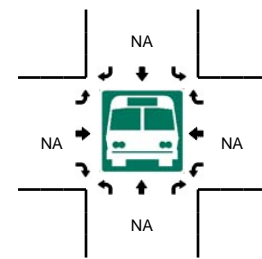
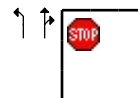
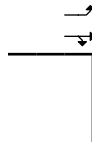
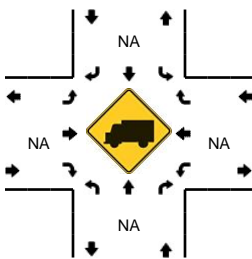
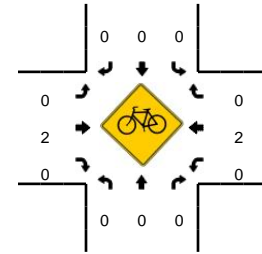
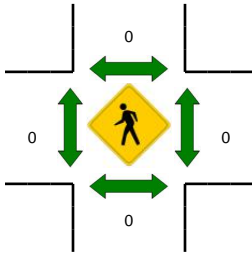
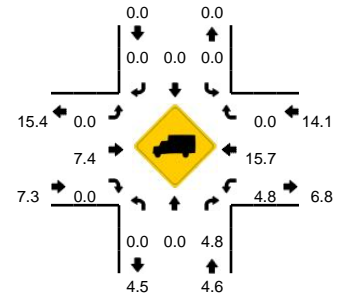

5-Min Count Period Beginning At	W 26th Ave (Northbound)				W 26th Ave (Southbound)				W Fourth Plain Blvd (Eastbound)				W Fourth Plain Blvd (Westbound)				Total	Hourly Totals
	Left	Thru	Right	U	Left	Thru	Right	U	Left	Thru	Right	U	Left	Thru	Right	U		
4:00 PM	2	0	7	0	0	0	0	0	0	36	0	0	0	11	0	0	56	
4:05 PM	1	0	5	0	0	0	0	0	0	46	0	0	0	14	0	0	67	
4:10 PM	1	0	14	0	0	0	0	0	0	25	0	0	0	8	0	0	50	
4:15 PM	1	0	9	0	0	0	0	0	0	17	1	0	0	20	0	0	48	
4:20 PM	0	0	5	0	1	0	0	0	0	16	1	0	0	14	0	0	37	
4:25 PM	0	0	1	0	0	0	0	0	0	22	0	0	0	14	0	0	37	
4:30 PM	0	0	2	0	6	0	0	0	0	22	0	0	0	9	0	0	40	
4:35 PM	0	0	7	0	0	0	0	0	0	34	0	0	0	8	0	0	50	
4:40 PM	0	0	5	0	0	0	0	0	0	26	0	0	0	13	0	0	45	
4:45 PM	0	1	13	0	0	0	0	0	0	16	0	0	0	14	0	0	47	
4:50 PM	0	0	12	0	1	0	0	0	0	9	0	0	0	7	0	0	30	
4:55 PM	0	0	10	0	0	0	0	0	0	24	0	0	0	7	0	0	45	552
5:00 PM	0	0	2	0	0	0	0	0	0	33	0	0	0	12	0	0	51	547
5:05 PM	1	0	5	0	0	0	0	0	0	39	0	0	0	9	0	0	55	535
5:10 PM	0	0	3	0	0	0	0	0	0	32	0	0	0	11	0	0	47	532
5:15 PM	1	0	1	0	0	0	0	0	0	38	1	0	0	9	0	0	52	536
5:20 PM	0	0	1	0	0	0	0	0	0	17	0	0	0	8	0	0	28	527
5:25 PM	0	0	2	0	1	0	0	0	0	20	0	0	0	15	0	0	42	532
5:30 PM	0	0	1	0	0	0	0	0	0	23	0	0	0	3	1	0	31	523
5:35 PM	0	0	2	0	1	0	0	0	0	24	1	0	0	21	0	0	50	523
5:40 PM	0	0	1	0	0	0	0	0	0	11	0	0	0	6	0	0	24	502
5:45 PM	0	0	2	0	0	0	0	0	0	16	0	0	0	12	0	0	34	489
5:50 PM	0	0	2	0	0	0	0	0	0	11	0	0	0	4	0	0	24	483
5:55 PM	0	0	0	0	0	0	0	0	0	9	0	0	0	5	0	0	14	452
Peak 15-Min Flowrates	Northbound				Southbound				Eastbound				Westbound				Total	
	Left	Thru	Right	U	Left	Thru	Right	U	Left	Thru	Right	U	Left	Thru	Right	U		
All Vehicles	8	0	36	0	0	0	0	0	0	436	4	0	0	116	0	0	616	
Heavy Trucks	0	0	4	0	0	0	0	0	0	32	0	0	0	12	0	0	48	
Pedestrians	0	0	0	0	0	0	0	0	0	0	0	0	0	0	0	0	0	
Bicycles	0	0	0	0	0	0	0	0	0	1	0	0	0	2	0	0	3	
Railroad																		
Stopped Buses																		

Comments: