

**LOCATION:** NE Delfel Rd -- NE 179th St  
**CITY/STATE:** Vancouver, WA

**QC JOB #:** 10837002  
**DATE:** Tue, Oct 23 2012

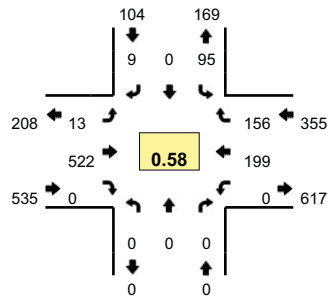

**Peak-Hour: 4:00 PM -- 5:00 PM**  
**Peak 15-Min: 4:05 PM -- 4:20 PM**

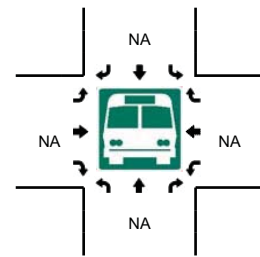
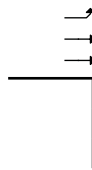
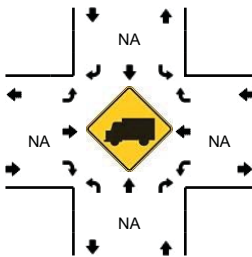
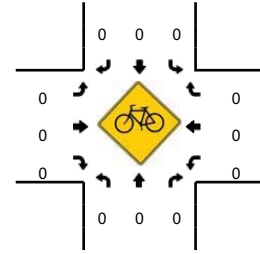
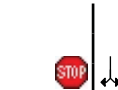
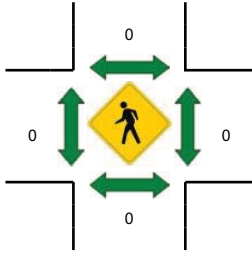
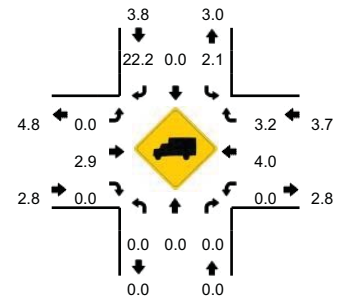

5-Min Count Period Beginning At	NE Delfel Rd (Northbound)				NE Delfel Rd (Southbound)				NE 179th St (Eastbound)				NE 179th St (Westbound)				Total	Hourly Totals
	Left	Thru	Right	U	Left	Thru	Right	U	Left	Thru	Right	U	Left	Thru	Right	U		
4:00 PM	0	0	0	0	11	0	1	0	1	22	0	0	0	12	12	0	59	
4:05 PM	0	0	0	0	10	0	2	0	1	93	0	0	0	11	10	0	127	
4:10 PM	0	0	0	0	3	0	1	0	2	116	0	0	0	17	20	0	159	
4:15 PM	0	0	0	0	7	0	1	0	1	105	0	0	0	17	15	0	146	
4:20 PM	0	0	0	0	14	0	1	0	2	49	0	0	0	19	10	0	95	
4:25 PM	0	0	0	0	6	0	1	0	0	24	0	0	0	15	13	0	59	
4:30 PM	0	0	0	0	7	0	0	0	1	27	0	0	0	20	5	0	60	
4:35 PM	0	0	0	0	9	0	0	0	0	20	0	0	0	18	15	0	62	
4:40 PM	0	0	0	0	10	0	0	0	2	14	0	0	0	13	12	0	51	
4:45 PM	0	0	0	0	4	0	1	0	1	21	0	0	0	14	18	0	59	
4:50 PM	0	0	0	0	9	0	0	0	0	15	0	0	0	18	12	0	54	
4:55 PM	0	0	0	0	5	0	1	0	2	16	0	0	0	25	14	0	63	994
5:00 PM	0	0	0	0	7	0	1	0	0	19	0	0	0	10	9	0	46	981
5:05 PM	0	0	0	0	15	0	0	0	1	11	0	0	0	25	17	0	69	923
5:10 PM	0	0	0	0	9	0	1	0	0	15	0	0	0	19	11	0	55	819
5:15 PM	0	0	0	0	13	0	0	0	0	22	0	0	0	12	12	0	59	732
5:20 PM	0	0	0	0	9	0	0	0	3	12	0	0	0	19	16	0	59	696
5:25 PM	0	0	0	0	17	0	0	0	0	14	0	0	0	11	13	0	55	692
5:30 PM	0	0	0	0	10	0	0	0	1	14	0	0	0	14	6	0	45	677
5:35 PM	0	0	0	0	7	0	0	0	0	11	0	0	0	19	13	0	50	665
5:40 PM	0	0	0	0	12	0	0	0	1	9	0	0	0	26	10	0	58	672
5:45 PM	0	0	0	0	8	0	1	0	0	9	0	0	0	25	10	0	53	666
5:50 PM	0	0	0	0	16	0	1	0	0	14	0	0	0	20	8	0	59	671
5:55 PM	0	0	0	0	6	0	0	0	0	21	0	0	0	17	11	1	56	664
Peak 15-Min Flowrates	Northbound				Southbound				Eastbound				Westbound				Total	
	Left	Thru	Right	U	Left	Thru	Right	U	Left	Thru	Right	U	Left	Thru	Right	U		
All Vehicles	0	0	0	0	80	0	16	0	16	1256	0	0	0	180	180	0	1728	
Heavy Trucks	0	0	0	0	0	0	8	0	0	12	0	0	0	8	8	0	36	
Pedestrians	0	0	0	0	0	0	0	0	0	0	0	0	0	0	0	0	0	
Bicycles	0	0	0	0	0	0	0	0	0	0	0	0	0	0	0	0	0	
Railroad																		
Stopped Buses																		

Comments: