

LOCATION: NW 11th Ave -- NW 139th St
CITY/STATE: Vancouver, WA

QC JOB #: 10837009
DATE: Tue, Oct 23 2012

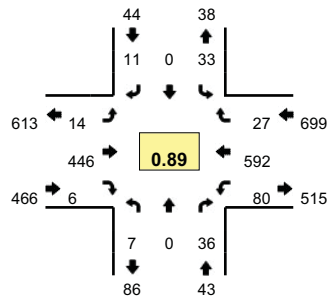

Peak-Hour: 4:35 PM -- 5:35 PM
Peak 15-Min: 5:20 PM -- 5:35 PM

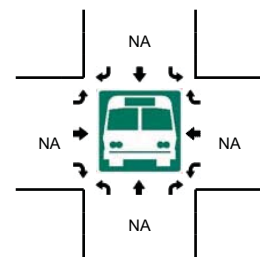
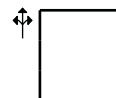
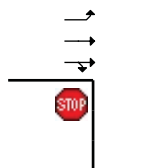
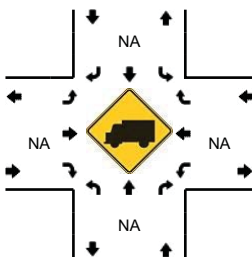
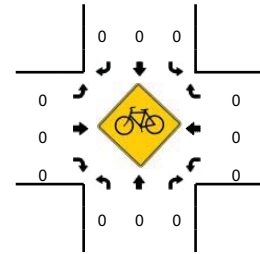
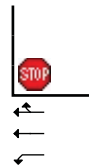
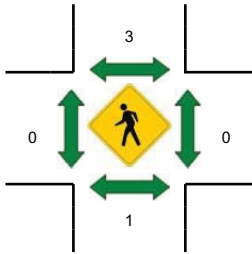
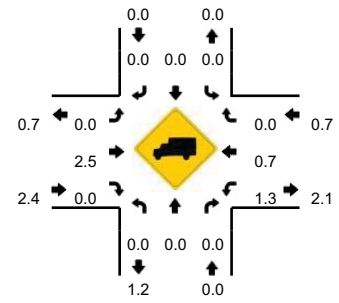

5-Min Count Period Beginning At	NW 11th Ave (Northbound)				NW 11th Ave (Southbound)				NW 139th St (Eastbound)				NW 139th St (Westbound)				Total	Hourly Totals
	Left	Thru	Right	U	Left	Thru	Right	U	Left	Thru	Right	U	Left	Thru	Right	U		
4:00 PM	3	0	5	0	5	0	0	0	2	46	0	0	7	33	5	0	106	
4:05 PM	0	0	1	0	3	1	0	0	1	28	0	0	4	33	1	0	72	
4:10 PM	1	0	5	0	2	0	3	0	1	25	0	0	3	29	3	0	72	
4:15 PM	0	0	5	0	3	0	1	0	0	33	1	0	2	42	0	0	87	
4:20 PM	0	0	3	0	0	0	0	0	0	31	0	0	3	35	1	0	73	
4:25 PM	1	0	6	0	0	0	0	0	0	36	0	0	4	40	0	0	87	
4:30 PM	0	0	1	0	1	0	2	0	1	32	1	0	3	48	4	0	93	
4:35 PM	1	0	2	0	0	0	1	0	1	34	1	0	5	46	1	0	92	
4:40 PM	0	0	3	0	2	0	1	0	0	26	0	1	9	25	3	0	70	
4:45 PM	0	0	3	0	3	0	3	0	1	35	0	1	4	59	7	0	116	
4:50 PM	1	0	1	0	7	0	0	0	3	40	0	0	3	47	5	0	107	
4:55 PM	2	0	4	0	7	0	1	0	0	35	0	0	4	37	2	0	92	1067
5:00 PM	1	0	3	0	3	0	0	0	2	38	1	0	8	63	0	0	119	1080
5:05 PM	1	0	4	0	1	0	0	0	1	39	0	0	6	48	2	0	102	1110
5:10 PM	0	0	7	0	3	0	2	0	3	37	1	0	9	47	2	0	111	1149
5:15 PM	0	0	0	0	5	0	2	0	0	39	1	0	7	37	2	0	93	1155
5:20 PM	0	0	3	0	2	0	0	0	0	38	2	0	12	61	2	0	120	1202
5:25 PM	1	0	4	0	0	0	1	0	0	38	0	0	6	67	0	0	117	1232
5:30 PM	0	0	2	0	0	0	0	0	0	47	0	1	7	55	1	0	113	1252
5:35 PM	0	0	1	0	0	0	0	0	1	32	1	0	8	49	0	0	92	1252
5:40 PM	0	0	1	0	0	0	0	0	0	23	0	0	5	37	1	0	67	1249
5:45 PM	0	0	8	0	1	0	0	0	2	33	0	0	9	56	0	0	109	1242
5:50 PM	0	0	5	0	0	0	0	0	2	27	1	0	7	45	1	0	88	1223
5:55 PM	0	0	3	0	0	0	3	0	0	20	0	0	3	43	0	0	72	1203
Peak 15-Min Flowrates	Northbound				Southbound				Eastbound				Westbound				Total	
	Left	Thru	Right	U	Left	Thru	Right	U	Left	Thru	Right	U	Left	Thru	Right	U		
All Vehicles	4	0	36	0	8	0	4	0	0	492	8	4	100	732	12	0	1400	
Heavy Trucks	0	0	0	0	0	0	0	0	0	4	0	0	4	4	0	0	12	
Pedestrians	0	0	0	0	0	4	0	0	0	0	0	0	0	0	0	0	4	
Bicycles	0	0	0	0	0	0	0	0	0	0	0	0	0	0	0	0	0	
Railroad																	0	
Stopped Buses																		

Comments: