

LOCATION: SE 192nd Ave -- SE 20th St
CITY/STATE: Camas, WA

QC JOB #: 14421306
DATE: Wed, May 24 2017

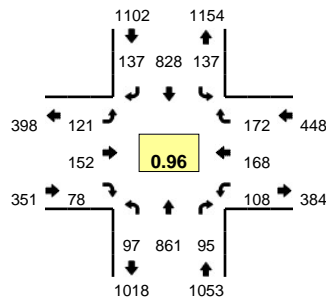

Peak-Hour: 4:35 PM -- 5:35 PM
Peak 15-Min: 5:00 PM -- 5:15 PM

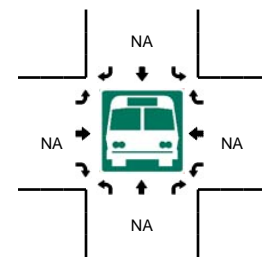
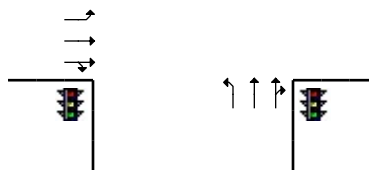
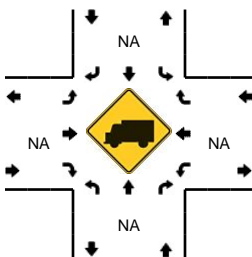
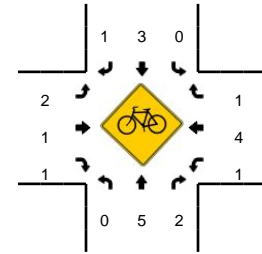
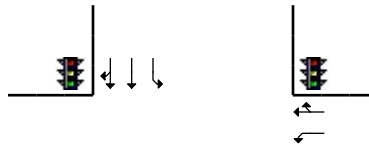
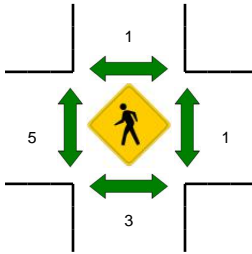
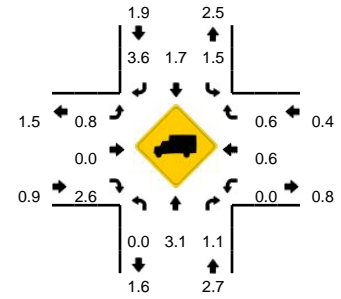

5-Min Count Period Beginning At	SE 192nd Ave (Northbound)				SE 192nd Ave (Southbound)				SE 20th St (Eastbound)				SE 20th St (Westbound)				Total	Hourly Totals
	Left	Thru	Right	U	Left	Thru	Right	U	Left	Thru	Right	U	Left	Thru	Right	U		
4:00 PM	8	53	4	0	12	60	14	0	13	8	4	0	7	14	9	0	206	
4:05 PM	6	66	4	0	7	73	13	0	11	16	6	0	10	13	11	0	236	
4:10 PM	7	58	3	0	7	72	8	0	6	8	4	0	3	12	8	0	196	
4:15 PM	7	49	2	0	10	62	6	0	15	14	5	0	6	12	10	0	198	
4:20 PM	12	78	6	0	10	77	12	0	11	12	5	0	7	11	6	0	247	
4:25 PM	11	74	6	1	10	67	10	0	11	18	9	0	11	9	6	0	243	
4:30 PM	7	60	2	1	14	77	16	0	13	11	3	0	8	10	11	0	233	
4:35 PM	9	80	8	0	9	82	7	0	7	7	5	0	10	12	22	0	258	
4:40 PM	9	49	6	0	7	70	20	0	7	12	8	0	9	11	13	0	221	
4:45 PM	7	71	9	1	11	58	14	0	12	14	9	0	10	14	15	0	245	
4:50 PM	11	76	9	0	13	56	12	0	6	16	3	0	6	13	3	0	224	
4:55 PM	6	71	10	1	13	72	16	0	14	12	7	0	7	15	13	0	257	2764
5:00 PM	6	63	6	1	9	64	13	0	15	11	8	0	9	17	7	0	229	2787
5:05 PM	8	81	6	1	9	75	13	0	9	19	3	0	13	23	16	0	276	2827
5:10 PM	3	71	4	0	15	92	12	0	7	14	6	0	12	16	16	0	268	2899
5:15 PM	11	66	6	0	9	72	4	0	8	9	6	0	9	7	18	0	225	2926
5:20 PM	9	73	13	0	13	59	9	0	17	11	15	0	5	18	15	0	257	2936
5:25 PM	5	86	9	0	14	61	11	0	6	17	4	0	9	10	15	0	247	2940
5:30 PM	9	74	9	0	15	67	6	0	13	10	4	0	9	12	19	0	247	2954
5:35 PM	7	68	6	0	15	61	9	0	14	17	8	0	5	17	9	0	236	2932
5:40 PM	6	61	4	0	8	86	5	0	13	9	4	0	6	15	5	0	222	2933
5:45 PM	9	50	5	0	10	82	9	0	10	15	9	0	7	10	14	0	230	2918
5:50 PM	6	65	5	0	4	67	10	0	15	6	2	0	9	14	8	0	211	2905
5:55 PM	8	43	3	0	10	68	6	0	9	9	3	0	3	5	5	0	172	2820
Peak 15-Min Flowrates	Northbound				Southbound				Eastbound				Westbound				Total	
	Left	Thru	Right	U	Left	Thru	Right	U	Left	Thru	Right	U	Left	Thru	Right	U		
All Vehicles	68	860	64	8	132	924	152	0	124	176	68	0	136	224	156	0	3092	
Heavy Trucks	0	20	0		4	16	4		4	0	0		0	0	0		48	
Pedestrians		4				0				0				0			4	
Bicycles	0	2	0		0	2	0		1	0	0		0	0	0		5	
Railroad																		
Stopped Buses																		

Comments: